

Accuphase

INTEGRATED STEREO AMPLIFIER

E-305

- Triple parallel push-pull output stage delivers 130 watts per channel (8 ohms)
- Low-impedance drive capability
- All direct coupled DC servo design from MC input to speaker output
- Balanced inputs
- Signal switching with logic controlled relays
- Peak power meters



All direct coupled circuitry with DC servo design for straight and pure signal. MC input to speaker outputs. Full drive capability for impedances as low as 2 ohms.

- 1 Single-chip dual NPN transistor
- 2 Single-chip dual FET
- 3 Single-chip dual PNP transistor
- 4 Servo IC
- 5 Filter capacitors for drive stage power supply
- 6 Class A transistor predriver
- 7 N-ch power MOS FET driver
- 8 NPN output transistors
- 9 PNP output transistors
- 10 P-ch power MOS FET driver
- 11 Class A transistor predriver
- 12 Servo IC
- 13 Dual FET input cascode bootstrap circuit amplifier (left channel)
- 14 Output booster (left channel)
- 15 Current mirror circuits (left channel)
- 16 Triple parallel differential super low noise FETs (6 devices) (left channel)
- 17 Gain switching relay
- 18 Input impedance switching relay
- 19 Servo IC
- 20 Triple parallel differential super low noise FETs (6 devices) (right channel)
- 21 Current mirror circuits (right channel)
- 22 Low-noise regulated power supply
- 23 Output booster (right channel)
- 24 Dual FET input cascode bootstrap circuit amplifier (right channel)



▲ Power amplifier unit (single channel)
▼ Preamplifier section PCB

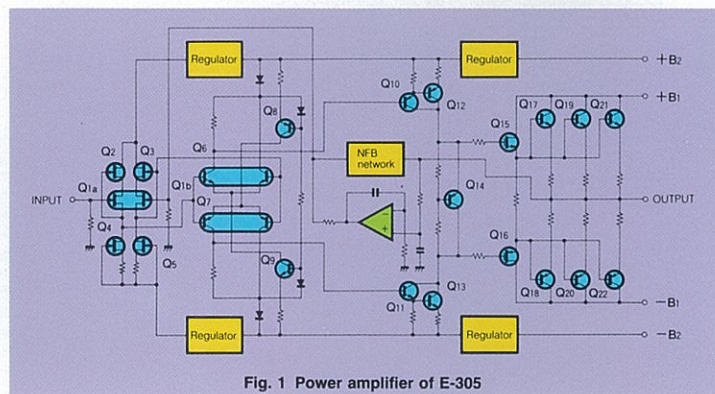
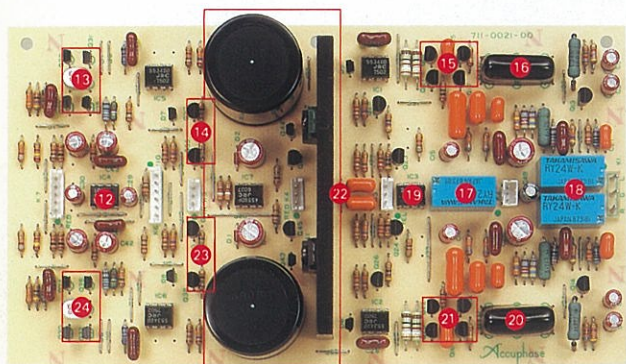

Fig. 1 Power amplifier of E-305

An integrated amplifier, as the name implies, combines all amplifying stages into a single chassis. This makes for easy operation, but it also makes it very difficult to achieve impeccable sound quality. The main reason for this predicament is that the total gain of such a unit exceeds 100 dB, which easily gives rise to mutual interference between the various stages.

Accuphase finally provides a solution which fulfills even the most severe audiophile demands. Drawing on our long experience in building separate type amplifiers of world renown, we have used only the finest materials and applied innovative design to create the E-305. It realizes the ultimate goal: to provide the quality of a stand-alone preamplifier and power amplifier in an integrated package.

The E-305 consists of a phono equalizer stage for reproduction of analog discs, a high-gain preamplifier, and a power amplifier. Each of these three units is optimized for the ultimate in performance. Interference between stages is effectively prevented by using separate power transformer windings for the phono and preamplifier stage and the power amplifier. The preamplifier employs sophisticated voltage regulator circuitry for utterly stable operation. Ingenious circuit design and parts layout combined with effective shielding further prevent the possibility of static or magnetic interference. The power amplifier draws on a highly capable power supply and employs a triple parallel push-pull design in the output stage. It delivers 130 watts per channel into 8 ohms and 180 watts per channel into 4 ohms. It can even drive 2-ohm loads with 250 watts of power per channel. This capability is desirable not only when using speakers with very low impedance ratings. Also with normal speakers, the

complexities of the musical signal can be conveyed more faithfully by an amplifier with superior low-impedance drive capacity.

For optimum flexibility, the E-305 provides a total of 10 inputs, so that it can effectively control the entire system. Two inputs are balanced types, offering ideal transmission characteristics. Versatile tape recorder facilities are another highlight of this amplifier. A REC selector lets you choose any source for recording, independent of the program reproduced over the speakers, and a TAPE COPY switch provides the capability for hassle-free tape dubbing. Tone controls and a loudness compensator circuit let you improve the tonal qualities of source material if required. As the tone controls employ the summing active filter principle, they have no detrimental effect on sound quality.

The design of the E-305 combines ease of operation with high visual appeal. Large power meters are arranged in the center of the front panel, flanked by the input selector to the left and a large volume control knob to the right. Switches for less frequently used functions are arranged behind a hinged panel, giving the amplifier an uncluttered appearance not unlike a power amplifier. The E-305 looks every bit as good as it sounds.

1 Powerful 3-parallel push-pull output stage reliably drives low-impedance loads and delivers 130 watts per channel into 8 ohms and 250 watts per channel into 2 ohms.

Fig. 1 shows the circuit design of the E-305. The output stage employs three pairs of bipolar transistors (Q17-Q22) in a parallel push-pull configuration. Each transistor has a maximum heat dissipation

(Pc) rating of 130 watts, resulting in a combined maximum heat dissipation of 780 watts. This generous design is very effective to drive low-impedance loads with ample power, but it also contributes to improved linearity when using speakers with normal impedance characteristics. The E-305 delivers 130 watts per channel into 8 ohms, 180 watts into 4 ohms, and a full 250 watts of high-quality power into 2 ohms.

2 Power drive stage with the quality of separate-type amplifiers

As can be seen from Fig. 1, the predriver circuit for the output stage employs MOS FET devices which are ideal for this purpose. They provide the required low output impedance and high drive voltage, resulting in operation equivalent to non-switching class A drive.

The input stage consists of the cascode connected devices Q1a and Q2, and Q1b and Q3. Together with the constant-current load Q4 and Q5, this ensures wide bandwidth and high linearity. The differential amplifier in the subsequent stage uses a complementary circuit with single-chip dual transistors. Low noise and extremely stable operation are the main advantages of this approach.

In every aspect, the power amplifier section of the E-305 rivals the performance of a separate-type amplifier.

3 Completely direct-coupled DC servo design from phono input all the way to the outputs

All unit amplifiers, from the phono input for analog discs up to the output stage, are linked directly, without any coupling capacitors in the signal path.

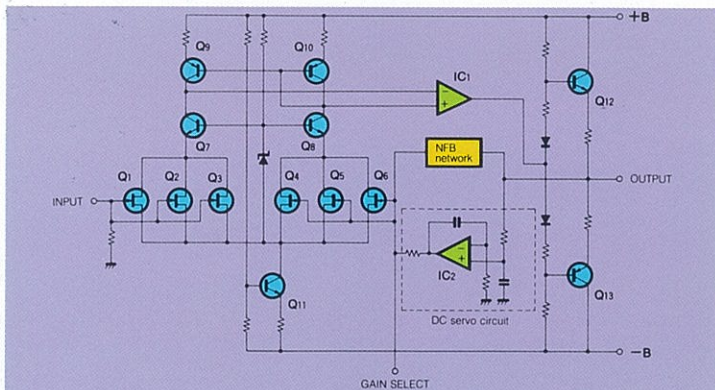

Fig. 2 Equalizer amplifier of E-305

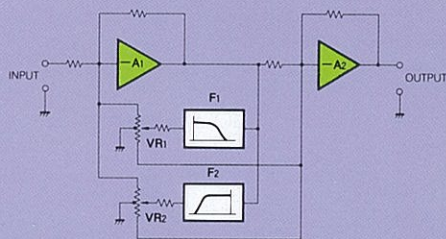

Fig. 3 Operating principle of E-305 tone controls (summing active filter type)

This is ideal for optimum amplifier performance and clean, uncolored sound. Any possibility of DC drift is effectively precluded by separate DC servo loops for each unit, resulting in rock-stable operation.

4 Separate power supply and voltage regulators for preamplifier and power amplifier eliminate mutual interference

The performance of conventional integrated amplifiers often suffers, as their overall gain is high, making the various stages susceptible to interference via the power supply or to static and magnetically induced interference. However, ingenious Accuphase engineering and our famous dedication to quality has now totally solved these problems.

The power transformer has totally separate windings for the preamplifier and power amplifier sections. The preamplifier further employs a highly sophisticated voltage regulator circuit, for impeccable performance on a par with high-class units on separate chassis. Various measures also reliably prevent static or magnetic interference.

5 High-performance phono stage accommodates all MC and MM cartridges.

Although digital program sources are becoming ever more popular, for a true audiophile and music lover, his analog record collection is a treasure he will not easily abandon. The E-305 is therefore designed to provide high-quality reproduction also of analog records.

As shown in Fig. 2, the gain of the phono stage is switchable to match either moving-coil (MC) or moving-magnet (MM) cartridges. In the MC position, gain is 60 dB, and in the MM position 30 dB. The input employs low-noise, high-Gm FET devices in a 3-parallel differential circuit with cascode bootstrap. The circuit is direct-coupled for superior signal-to-noise ratio and stability. The triple parallel design is perfectly suited to the low output levels of moving-coil cartridges, as it keeps residual noise to a minimum.

6 Straight and short signal paths with logic relay control

Long signal paths for functions such as input switching and tape monitoring tend to degrade

high-frequency response and impair imaging. In the E-305, all switching is performed by relays which are arranged so as to permit the shortest possible signal paths. These relays are controlled electronically by a logic circuit to assure accurate and precise operation.

The relays have twin crossbar contacts plated with silver palladium alloy for minimum contact resistance and outstanding long-term reliability.

7 Versatile input configuration including balanced connectors

In order to accommodate the ever increasing variety of program sources, the E-305 provides a total of 10 inputs. Unbalanced inputs are AD (analog disc), CD, TUNER, two TAPE inputs and three LINE inputs. To satisfy even the highest demands, the E-305 also possesses two balanced inputs marked LINE and CD. This permits connection of professional-class or high-end equipment, for balanced signal transmission with ideal transmission characteristics.

8 Separate REC selector and TAPE COPY switch

Together with the increasing number of program sources, many hobby recordists desire sophisticated recording and playback capabilities for tape decks. The E-305 is equipped to cope with any need. A separate REC selector lets you for example record an FM broadcast while listening to a CD. Dubbing between two tape recorders in any direction is also as easy as flicking a switch, thanks to the TAPE COPY selector.

9 Input/output terminals permit separate use of preamplifier and power amplifier

A set of input and output terminals on the rear panel permits "splitting" the E-305 into two entities in their own right. These terminals may be used to hook up external signal processors such as graphic equalizers, or they permit for example the combination of the E-305's power amplifier section with another preamplifier of your choice.

10 Tone controls using summing active filter circuits for highest sound quality

The energy balance of real-world program sources

is not always satisfactory, and speaker and listening characteristics frequently need some correction. Therefore it is convenient to have tone controls, but audiophiles often shun such circuits as they are thought to deteriorate sound quality. The tone controls of the E-305, however, are newly developed designs which use the same summing active filter principle found in high-quality graphic equalizers. The operating principle of these controls is shown in Fig. 3. The flat signal passes straight through, and necessary characteristics are produced in F₁ and F₂ and added to the signal, thereby producing the desired change. This design provides efficient control without degrading signal purity.

11 Direct-reading peak output meters

The large power meters arranged in the center of the front panel give the amplifier an appearance not unlike that of a power amplifier. The meters use logarithmic compression with peak-reading characteristics and are calibrated in watts, for highly accurate and meaningful indication of output levels. The subdued, pleasing illumination blends perfectly with any listening room.

12 Other features

Other useful controls and functions include a selector for two pairs of speakers, a mode switch to combine the left and right channels, a subsonic filter to cut off harmful low-frequency noise during phono playback, a loudness compensator to augment the aural impression at low listening levels, and a headphone jack. All of these are arranged behind a hinged door in the lower section of the front panel, giving the amplifier an uncluttered appearance. Only the volume control, the function selector and an attenuator switch are visible in normal operation. This design is a good example of intelligent human engineering.

13 Natural Persimmons Wood Side Panels

The front panel is finished in brushed gold aluminum, in the exquisite Accuphase tradition. The visual appeal of the amplifier is further enhanced by the natural beauty of the side panels made of persimmons wood.

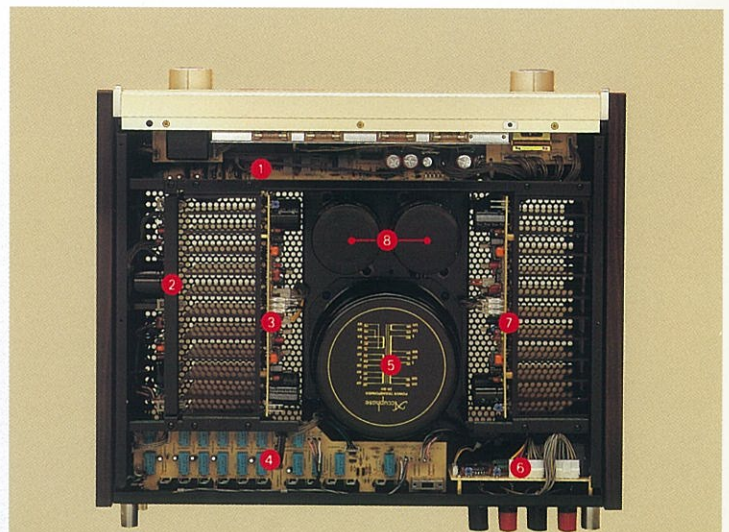

Internal layout

- 1 Summing active filter tone control PCB
- 2 Preamplifier section PCB
- 3 Right-channel power amplifier unit
- 4 Logic relay control PCB
- 5 Power transformer
- 6 Meter drive/protection PCB
- 7 Left-channel power amplifier unit
- 8 Filter capacitors

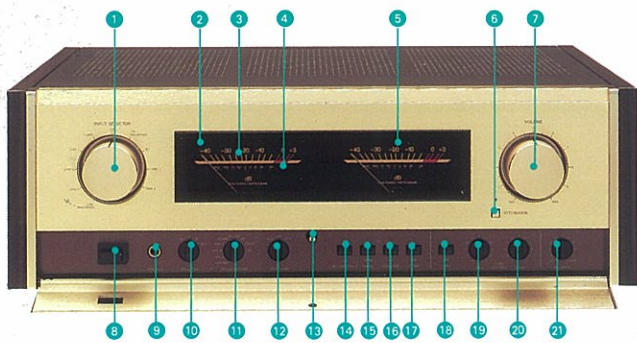

- 1 INPUT selector
LINE (BALANCED), LINE-3, LINE-2,
LINE-1, TUNER, CD, CD (BALANCED),
AD, TAPE-1, TAPE-2
- 2 Left-channel output level meter
- 3 Output meter dB scale
- 4 Output meter wattage scale
- 5 Right-channel output level meter
- 6 ATTENUATOR
- 7 VOLUME control
- 8 POWER switch
- 9 Headphone jack (PHONES)
- 10 SPEAKER selector
- 11 REC SELECTOR
LINE BAL, LINE-3, LINE-2, LINE-1,
TUNER, REC OFF, CD, CD BAL, AD
- 12 TAPE COPY selector
- 13 Subpanel magnet lock
- 14 Phono stage gain switch
(MC CARTRIDGE) ON (MC), OFF
- 15 MODE switch
STEREO, MONO
- 16 SUBSONIC filter switch
- 17 Loudness compensator switch (COMP)
- 18 TONE control ON/OFF switch
- 19 BASS control
- 20 TREBLE control
- 21 BALANCE control
- 22 Ground (GND) terminal
- 23 AD input jack
- 24 CD input jack
- 25 TUNER input jack

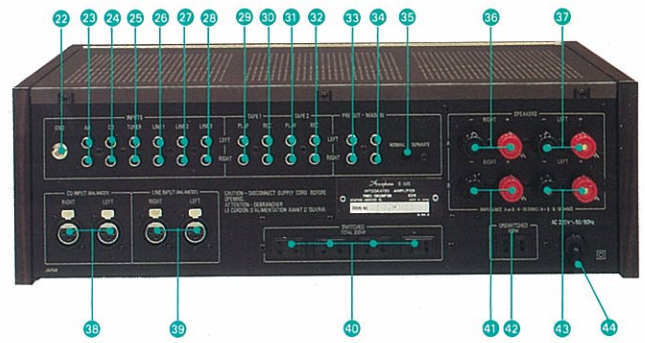

- 26 LINE-1 input jack
- 27 LINE-2 input jack
- 28 LINE-3 input jack
- 29 TAPE-1 input jack
- 30 TAPE-1 recording output jack
- 31 TAPE-2 input jack
- 32 TAPE-2 recording output jack
- 33 Preamplifier output jack
- 34 Power amplifier input jack
- 35 Preamplifier/power amplifier separator switch
- 36 Speaker A right channel output terminals
- 37 Speaker A left channel output terminals
- 38 CD (line) balanced input connectors
(corresponding to XLR-31 type,
suitable for XLR-3-12C type plugs; ①:
GND, ②: COLD, ③: HOT)
- 39 CD (line) balanced input connectors
- 40 Switched AC power outlets*
- 41 Speaker B right channel output terminals
- 42 Unswitched AC power outlets*
- 43 Speaker B left channel output terminals
- 44 AC power cord

Remarks:
* These SWITCHED and UNSWITCHED outlets may not be supplied depending on the safety standards or regulations applicable in the particular country to where the unit is destined.

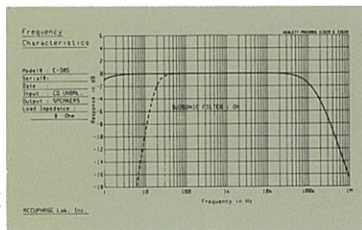

● Frequency response

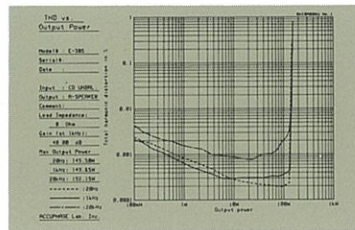

● Power output vs. THD (8-ohm load)

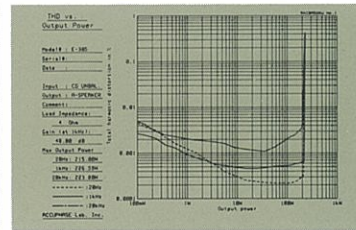

● Power output vs. THD (4-ohm load)

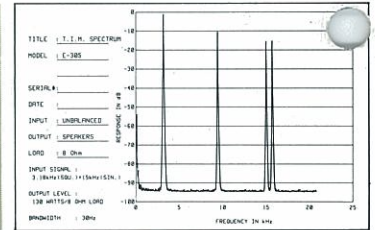

The above data shows the spectrum characteristics of transient intermodulation distortion for the E-305 when two mixed input signals, a 3.18 kHz square wave and a 15 kHz sine wave, are used. Since harmonics of square waves appear almost infinitely at odd-number multiples, for example in this case at 9.54 kHz (3rd harmonic) and 15.9 kHz (5th harmonic), they can create, together with the 15 kHz input sine wave, intermodulated spectrums at frequencies where input signals are absent. For example, if the third harmonic of the 3.18 kHz square wave (9.54 kHz) and the 15 kHz input signal intermodulate, a spectrum can appear at the difference of their frequencies, or 5.46 kHz (15-9.54=5.46 kHz). However, the above data shows no spectrum above -93 dB at that frequency. This confirms that TIM distortion is less than 0.0022%.

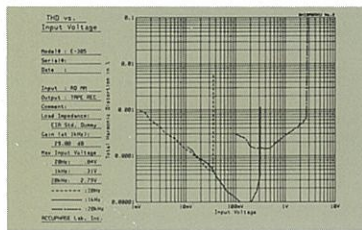

● Input voltage vs. THD (Input: AD MM, Output: TAPE REC)

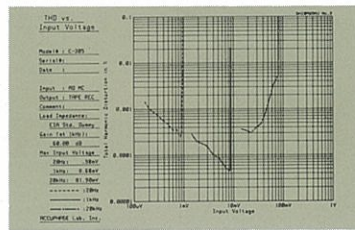

● Input voltage vs. THD (Input: AD MC, Output: TAPE REC)

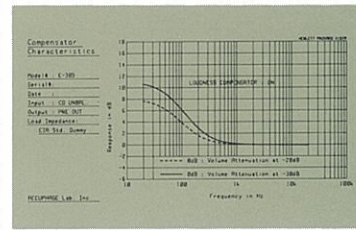

● Compensator frequency response

GUARANTY SPECIFICATIONS (Guaranteed specifications are measured according to EIA standard RS-490. AD denotes Analog Disc input.)

- **Performance guaranty**
All Accuphase product specifications are guaranteed as stated.
- **Continuous average output power**
180 watts per channel into 4 ohms
130 watts per channel into 8 ohms
(Both channels driven, 20-20,000 Hz, THD 0.02%)
- **Total harmonic distortion**
0.02%, with 4 to 16 ohms load
(both channels driven, from 0.25 W to rated continuous average output, 20-20,000 Hz)
- **Intermodulation distortion**
0.01%
- **Frequency response**
MAIN AMP INPUT: 20-20,000 Hz +0, -0.2 dB (for rated output)
0.5-150,000 Hz +0, -3.0 dB (for 1 watt output)
HIGH LEVEL INPUT: 20-20,000 Hz +0, -0.2 dB (for rated output)
LOW LEVEL INPUT: 20-20,000 Hz +0.2, -0.5 dB (for rated output)
- **Damping factor**
100 (with 8-ohm load, 50 Hz)

● **Input sensitivity and impedance**

Input terminal	Sensitivity		Impedance
	Rated output	EIA (1W output)	
AD INPUT (MC)	0.08 mV	0.007 mV	100 ohms
AD INPUT (MM)	2.5 mV	0.22 mV	47k ohms
HIGH LEVEL INPUT	120 mV	11.3 mV	20k ohms
BALANCED INPUT	120 mV	11.3 mV	40k ohms
MAIN AMP INPUT	1.23V	113 mV	20k ohms

- **Maximum AD input level**
MM: 300 mV rms, 1 kHz, THD 0.005% (REC OUT)
MC: 9.5 mV rms, 1 kHz, THD 0.005% (REC OUT)
- **Rated output level and impedance**
PRE OUTPUT: 1.23 V, 200 ohms
TAPE REC OUTPUT: 120 mV, 200 ohms (from AD input)
HEADPHONES: 0.4 V (suitable impedance: 4-100 ohms)
- **Gain**
MAIN INPUT → OUTPUT: 28 dB
HIGH LEVEL INPUT → PRE OUTPUT: 20 dB
AD INPUT (MM) → TAPE REC OUTPUT: 30 dB
AD INPUT (MC) → TAPE REC OUTPUT: 60 dB
- **Tone controls**
Turnover frequency and adjustment range
BASS: 300 Hz ±10 dB (50 Hz)
TREBLE: 3 kHz ±10 dB (20 kHz)
- **Loudness compensation**
+6 dB (100 Hz)
(Volume control setting -30 dB)

● **Signal-to-noise ratio**

Input terminal	Rated Input A-weighted	EIA
MAIN AMP INPUT	123 dB	102 dB
HIGH LEVEL INPUT	108 dB	82 dB
BALANCED INPUT	90 dB	82 dB
AD INPUT (MM)	86 dB	80 dB
AD INPUT (MC)	66 dB	75 dB

- **Subsonic filter characteristics**
Cutoff frequency 17 Hz, -12 dB/oct
- **Attenuator characteristics**
-20 dB
- **Power level meters**
Logarithmic compression, peak reading meters dB and direct watt-reading (8-ohm load) scale
- **Load impedance**
4-16 ohms
- **Semiconductor complement**
77 transistors, 34 FETs, 20 ICs, 78 diodes
- **Power requirements**
100 V, 117 V, 220 V, 240 V 50/60 Hz AC
- **Power Consumption**
Idle: 60 watts
At rated output into 8 ohms: 490 watts
- **Dimensions**
475 mm (18-23/32 inches) width, 170 mm (6-11/16 inches) max. height, 375 mm (14-49/64 inches) depth mm
- **Weight**
20.5 kg (45.1 lb) net, 24.5 kg (53.9 lb) in shipping carton

